

5) Travaux dirigés

TD N :1

1. Mettre sur la vue convenable le repère de chaque surface

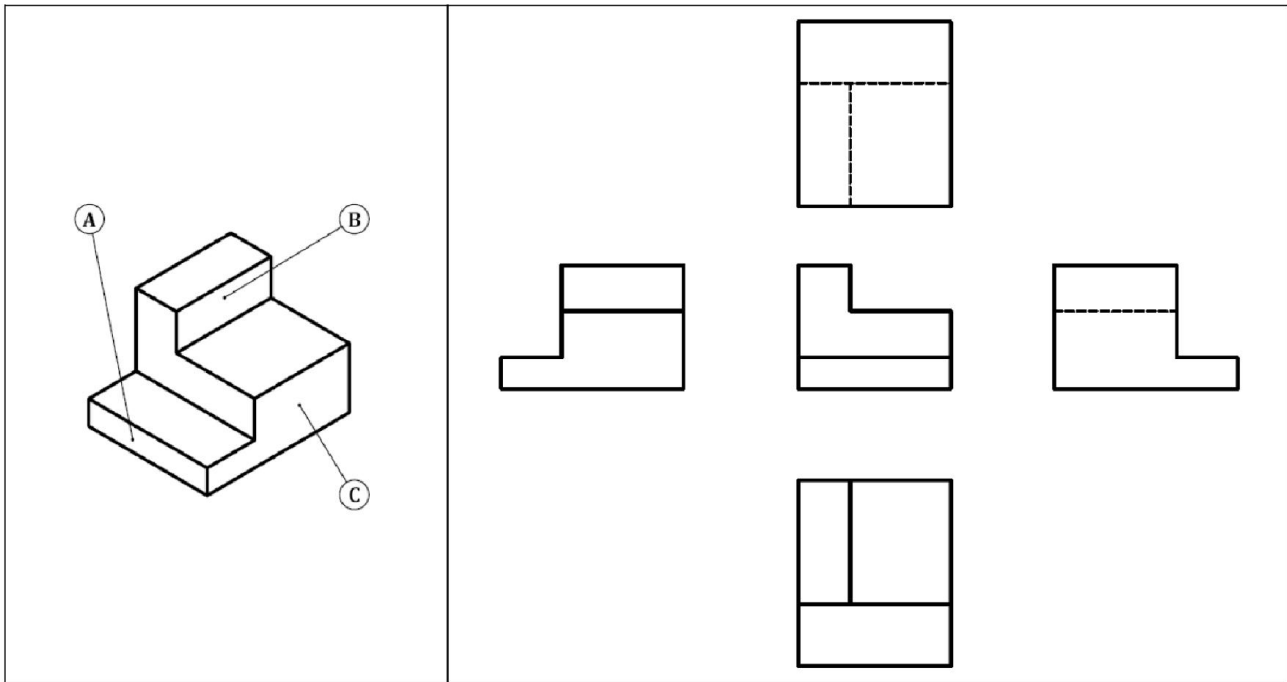

TD N :2

Indiquer sur le dessin en perspective par une flèche légendée les directions d'observation donnant les vues de droite, de gauche et de dessus.

Indiquer le numéro de chacune des Vues suivantes:

- Vue de Face
- Vue de Droite
- Vue de gauche
- Vue de dessus.

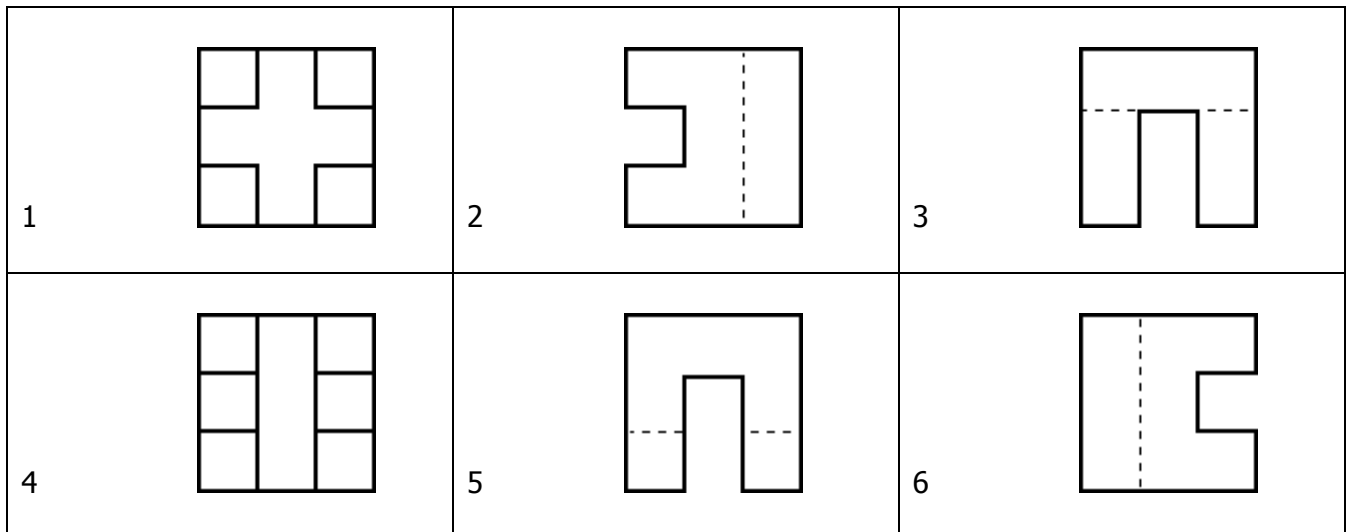
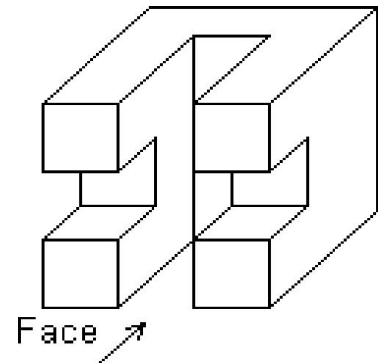

REPRESENTATION GRAPHIQUE

2SMB

TD N :3

Indiquer le numéro de chacune des Vues suivantes:

- Vue de Face
- Vue de Droite
- Vue de gauche
- Vue de dessus.

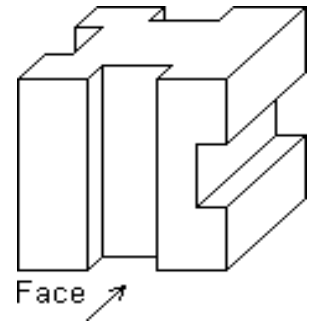

1		2		3	
4		5		6	

TD N :4

Indiquer le numéro de chacune des Vues suivantes:

- Vue de Face
- Vue de Droite
- Vue de gauche
- Vue de dessus.

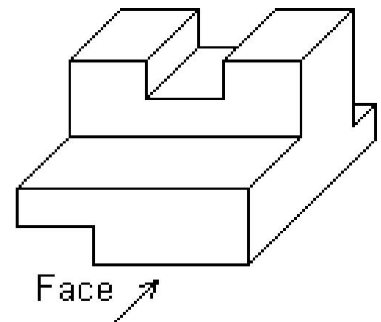

1		2		3	
4		5		6	

REPRESENTATION GRAPHIQUE

2SMB

TD N :5

Indiquer le numéro de chacune des Vues suivantes:

- Vue de Face
- Vue de Droite
- Vue de gauche
- Vue de dessus.

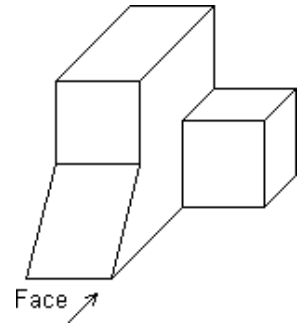

1	2	3
4	5	6

TD N: 6

Compléter la vue de face, la vue de droite et la vue de dessus.

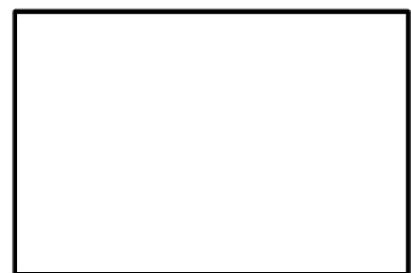
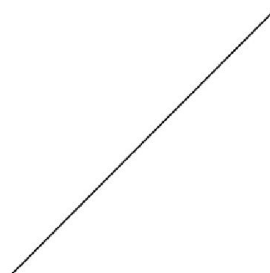
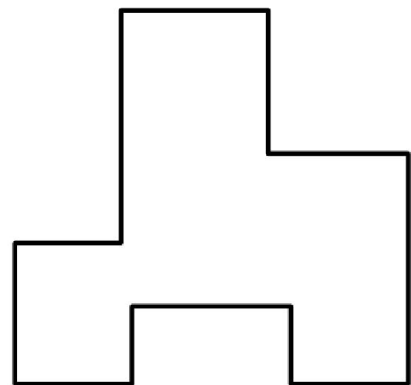
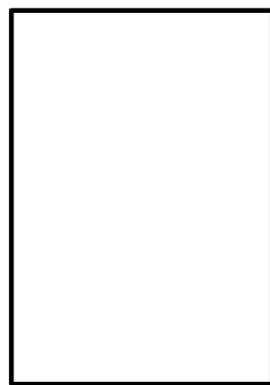
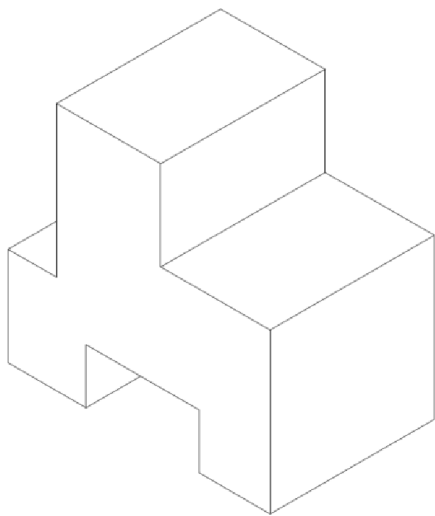

REPRESENTATION GRAPHIQUE

2SMB

- D N: 7
compléter les vues

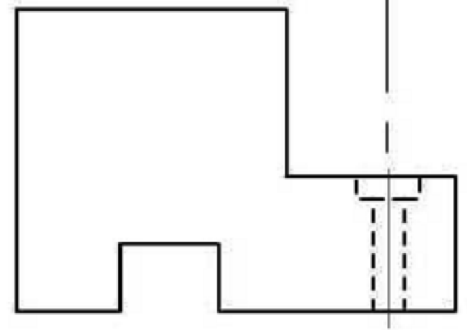
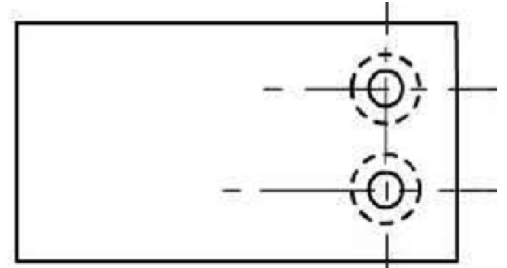
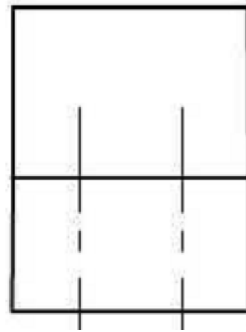
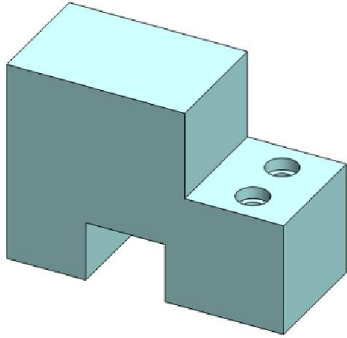

- D N: 8
compléter les 3 vues

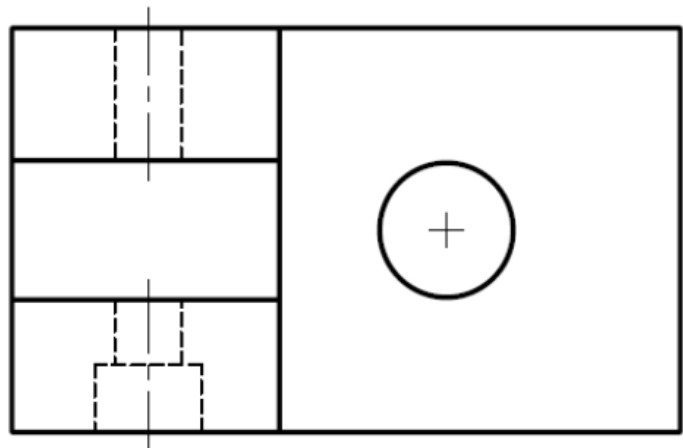
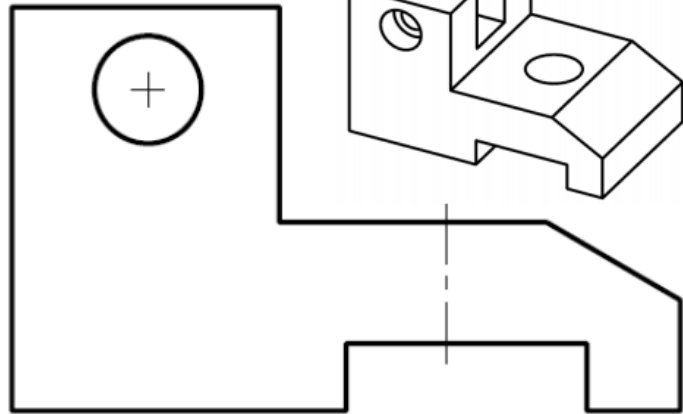
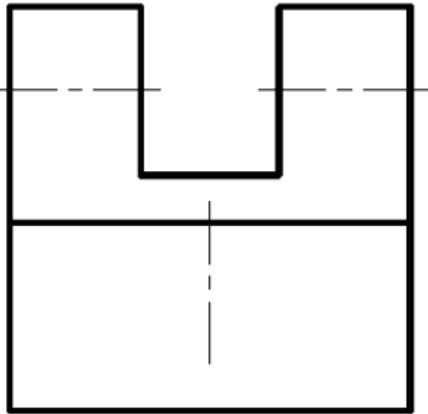

REPRESENTATION GRAPHIQUE

2SMB

TD N: 9

compléter les 3 vues

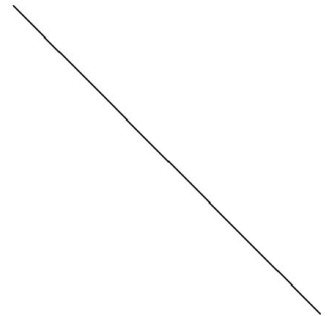
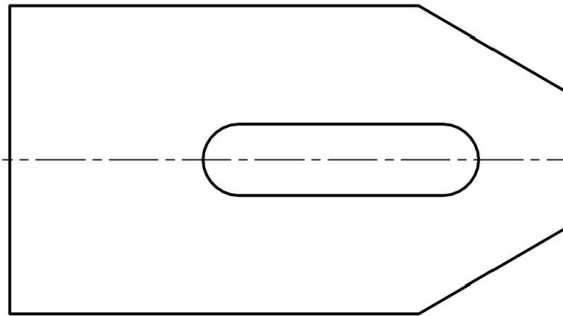
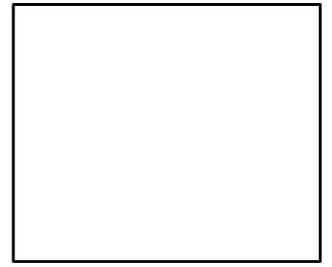
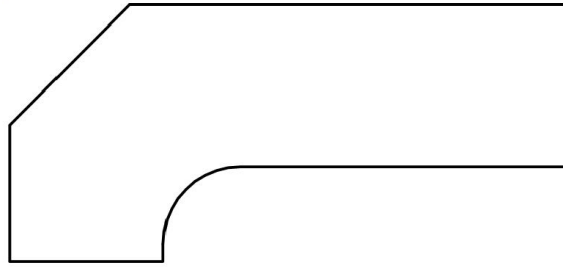
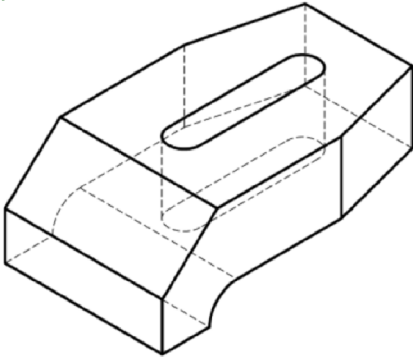

▪ TD N: 10

compléter les 3 vues des deux pieces suivantes:

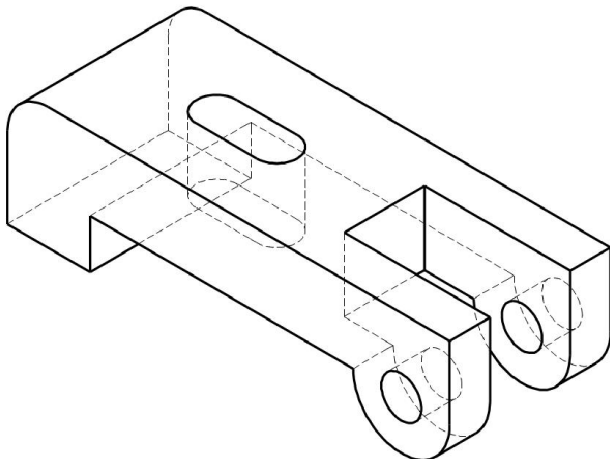
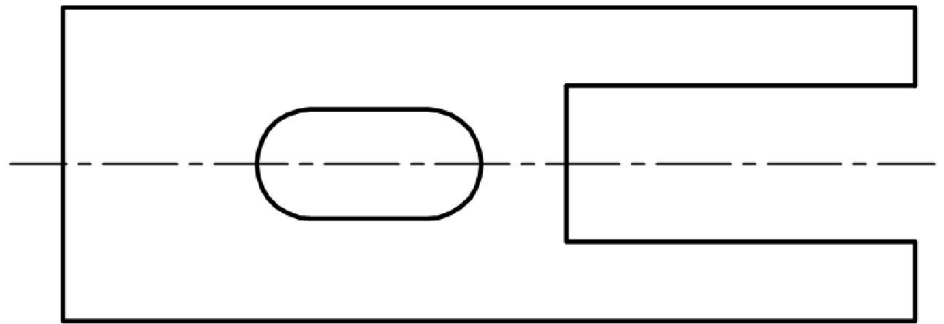
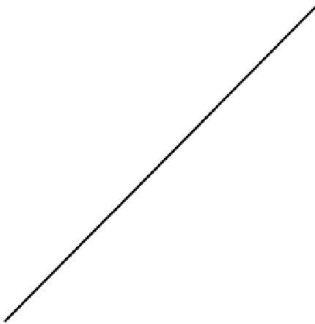
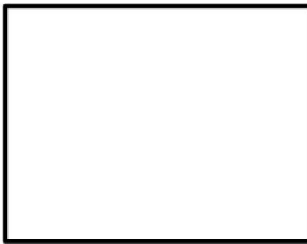

REPRESENTATION GRAPHIQUE

2SMB

▪ **TD N:11**

Compléter les vues suivantes

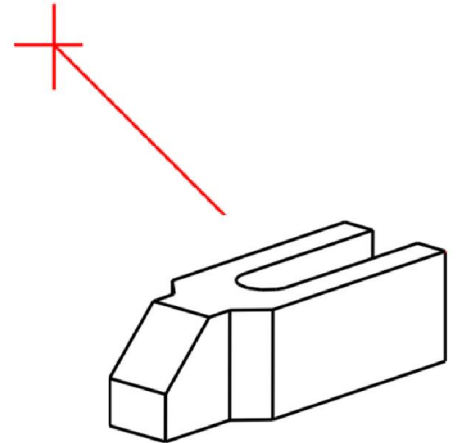
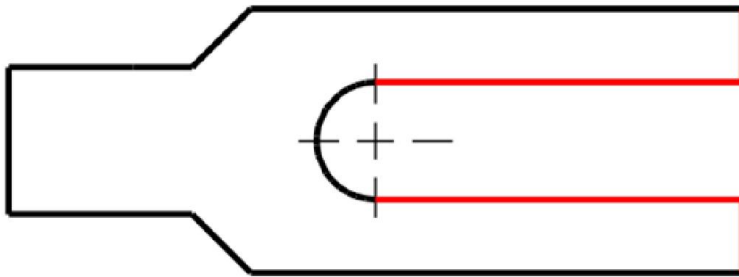
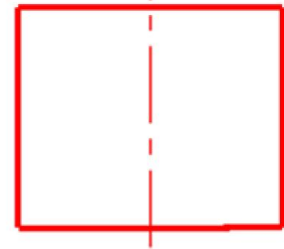

▪ **TD N:12**

Compléter les vues suivantes

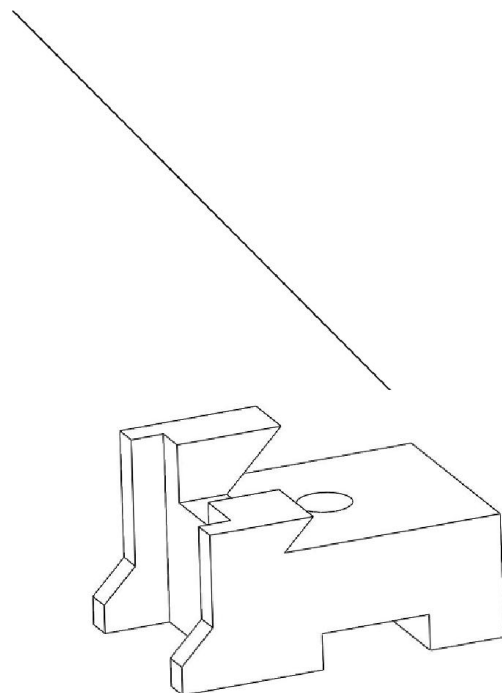
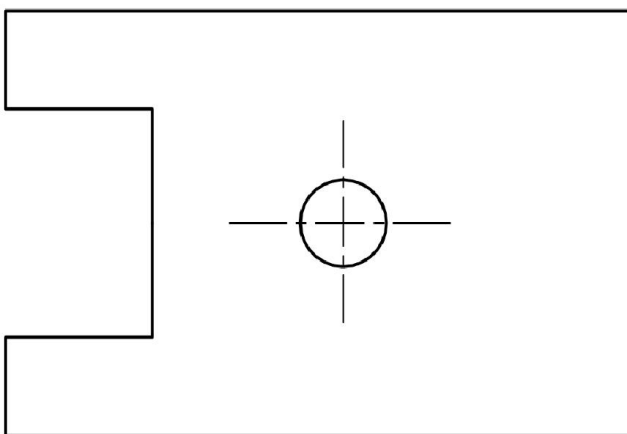
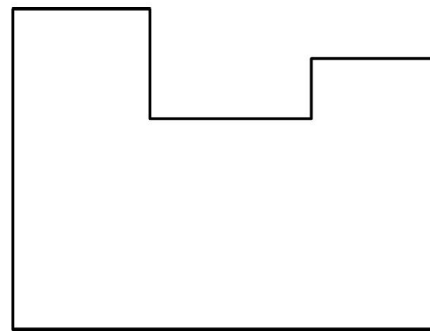
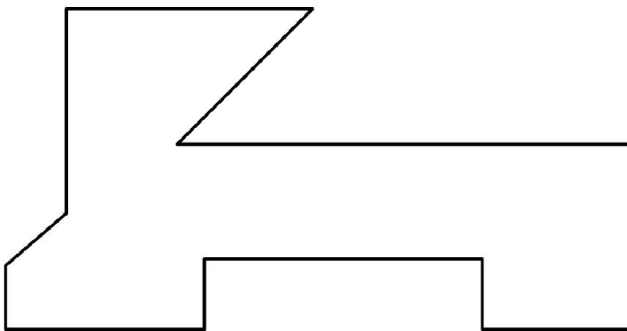

REPRESENTATION GRAPHIQUE

2SMB

▪ TD N: 13

Compléter les vues des pieces suivantes

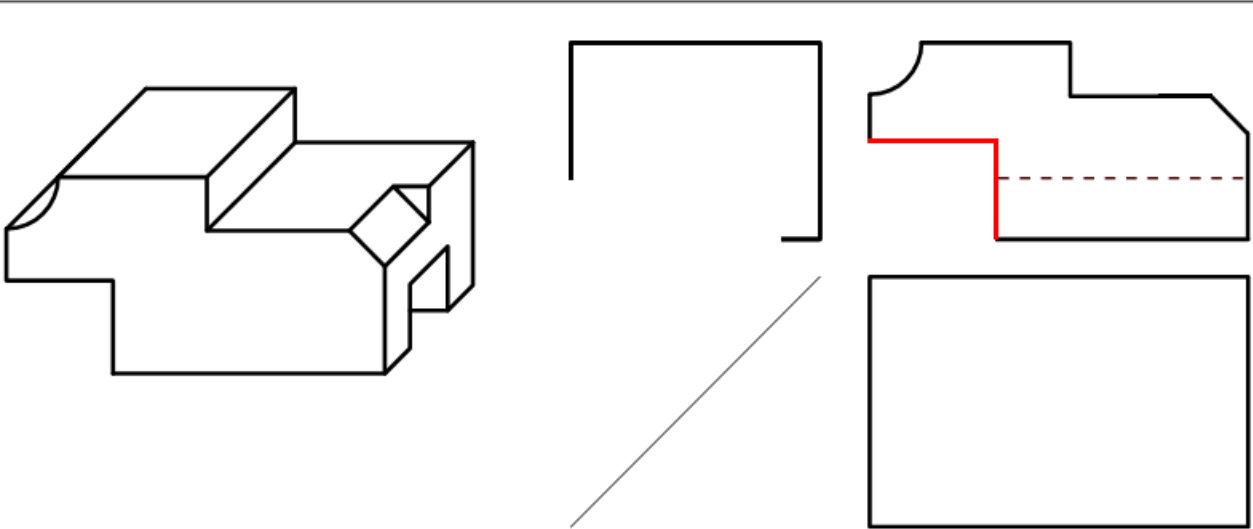
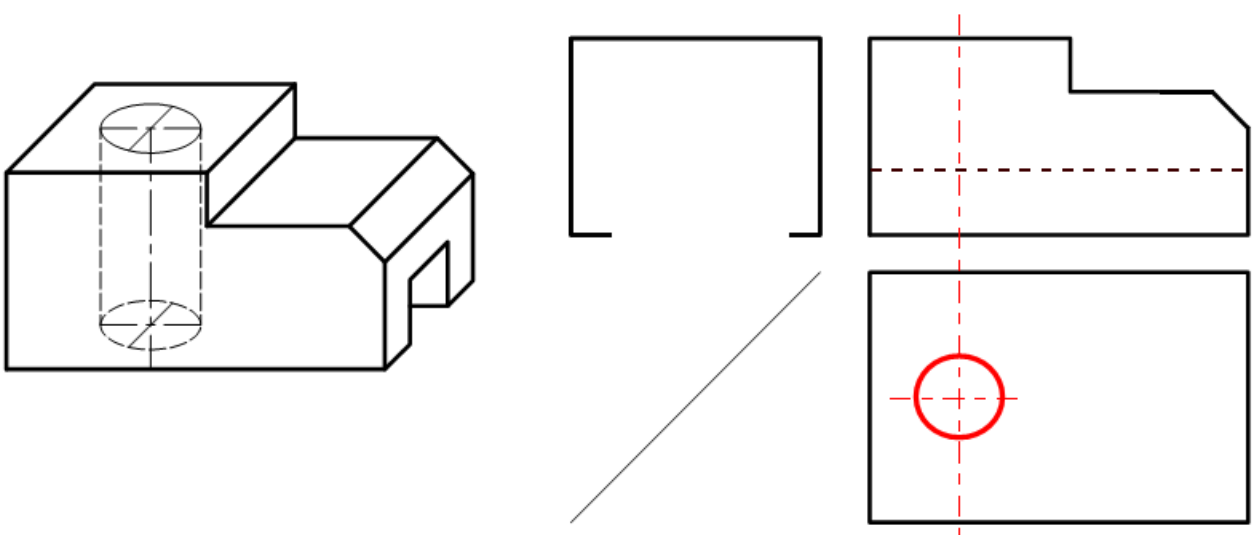
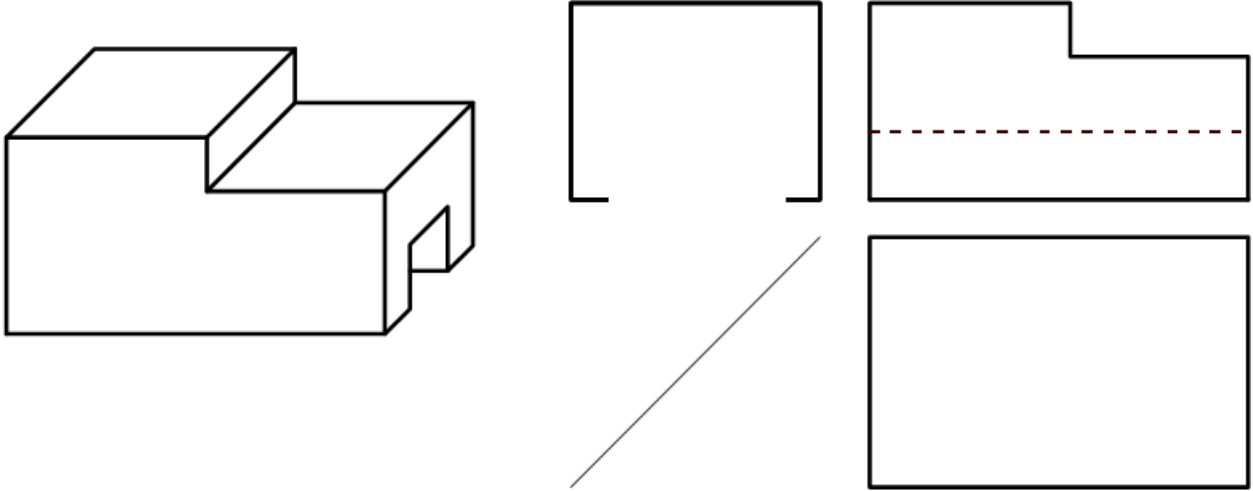

TD N: 14

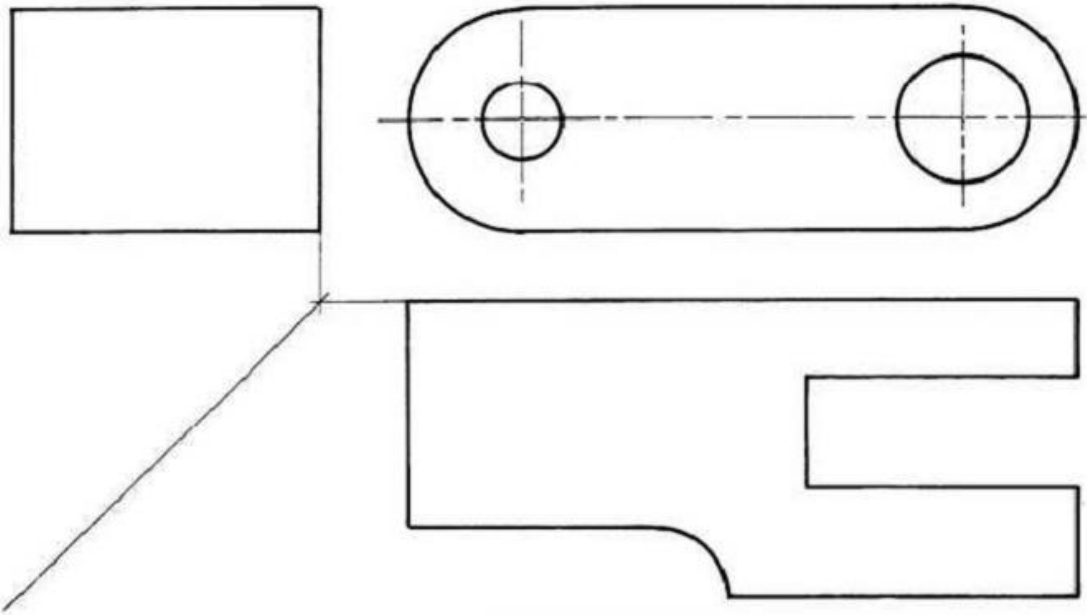

- 1) Esquisser les détails sur les trois vues.
- 2) Faire la mise au net.

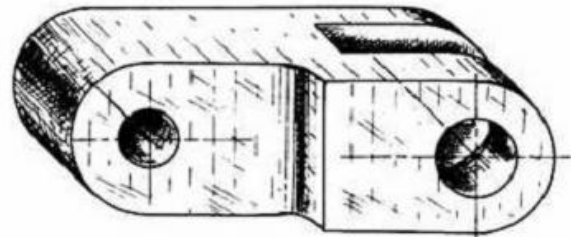

- 1) Esquisser le rectangle capable de la vue de droite.
- 2) Esquisser les détails sur toutes les vues.
- 3) Faire la mise au net.
- 4) Repasser en couleur l'arête repérée sur la perspective.

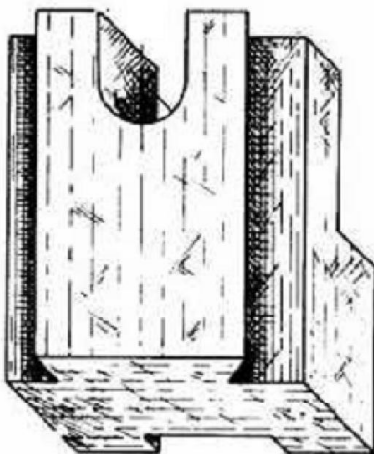
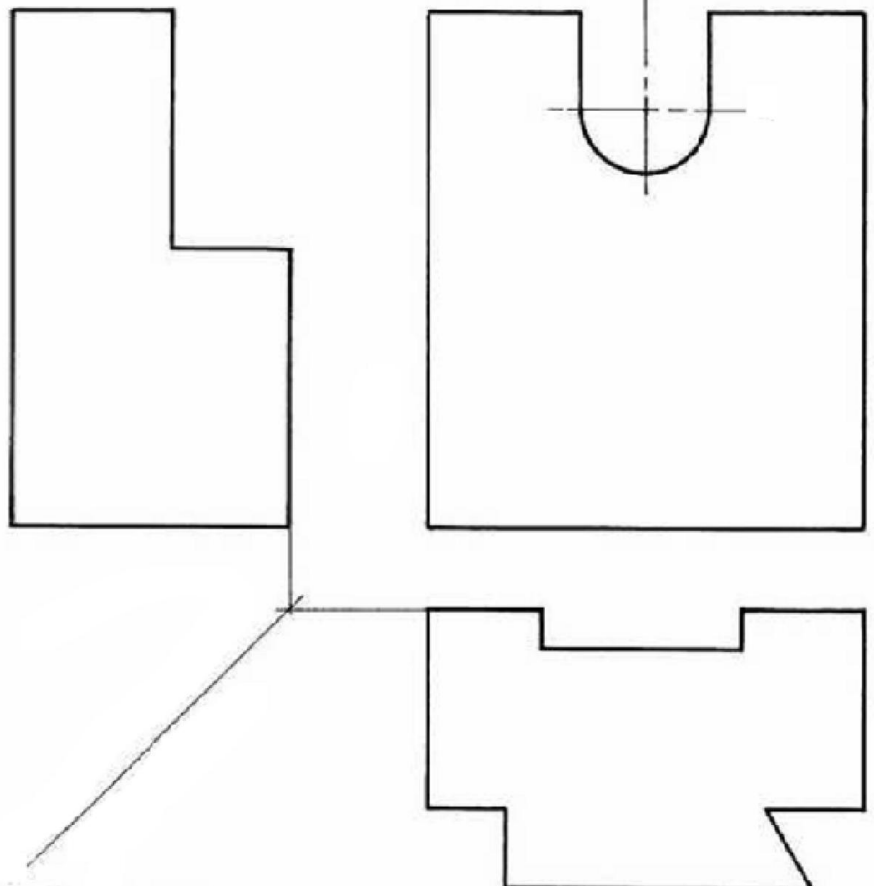

REPRESENTATION GRAPHIQUE

2SMB

- 1) Esquisser le rectangle capable de la vue de droite.
- 2) Esquisser les différents détails sur les trois vues.
- 3) Faire la mise au net.
- 4) Repasser en couleur les arêtes repérées sur la perspective.

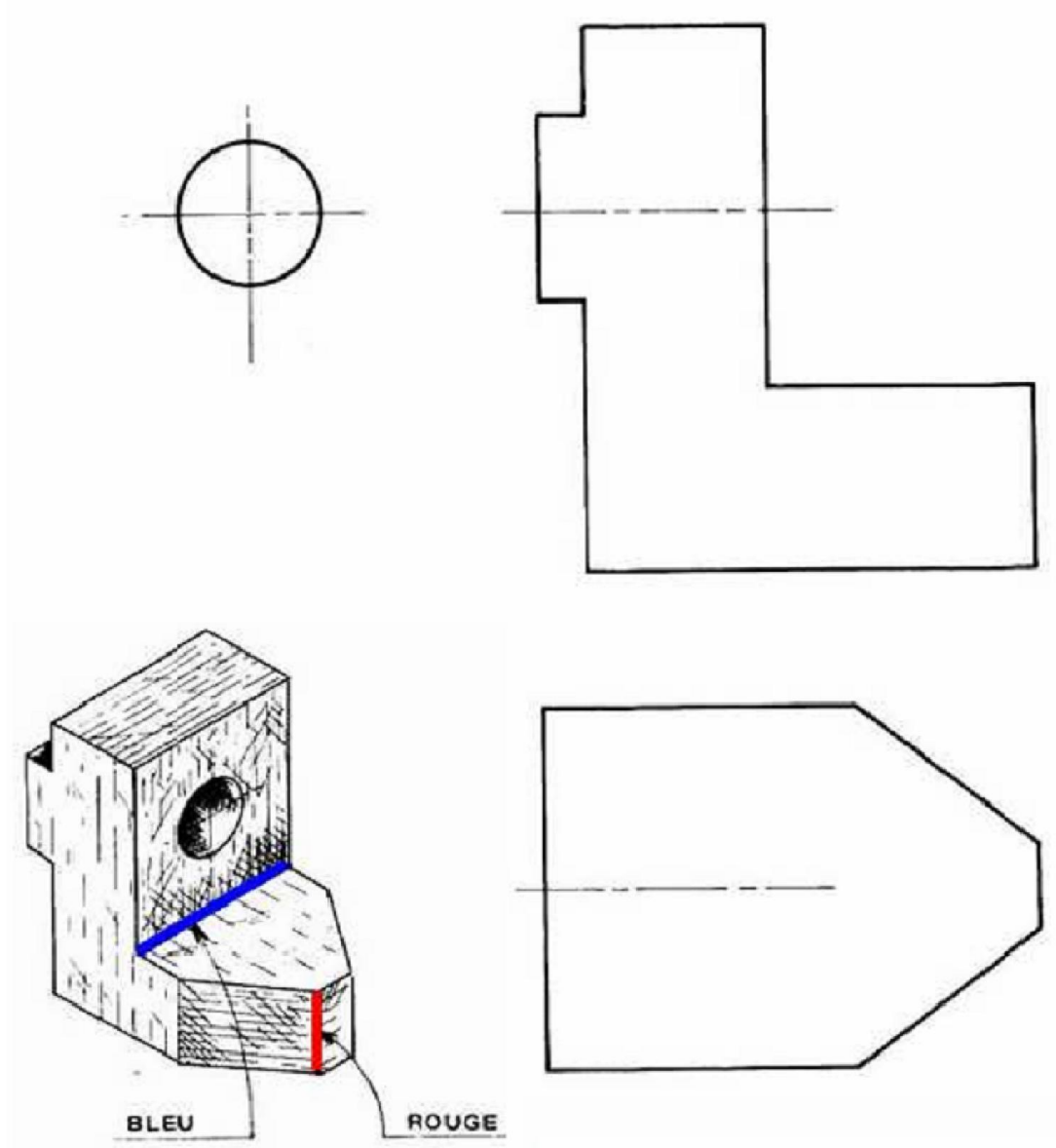

REPRESENTATION GRAPHIQUE

2SMB

▪ **TD N: 15**

Compléter les vues incomplètes

