

Liaisons et Assemblages

Représentation des filetages

.I Vocabulaire

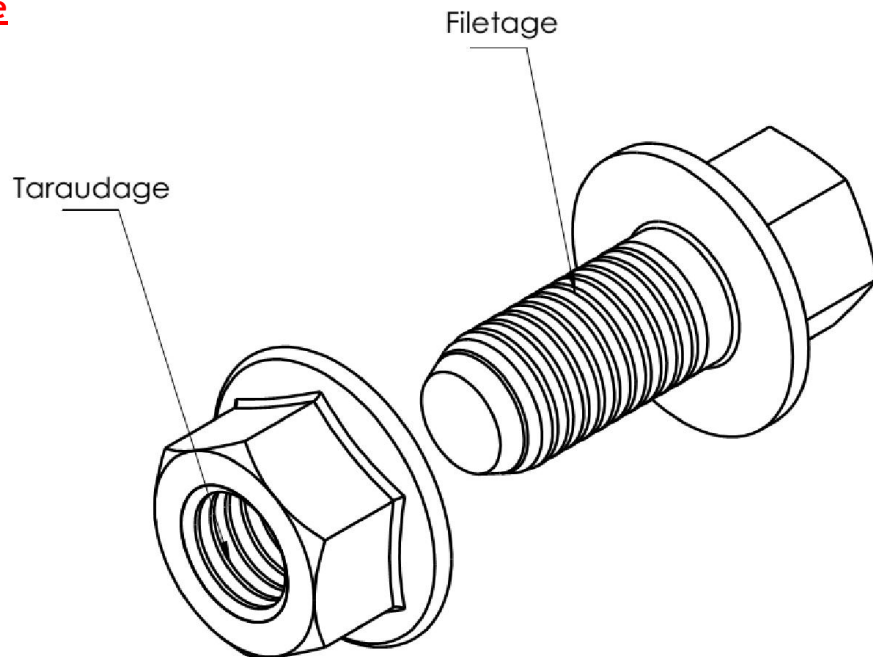

.II Filetage

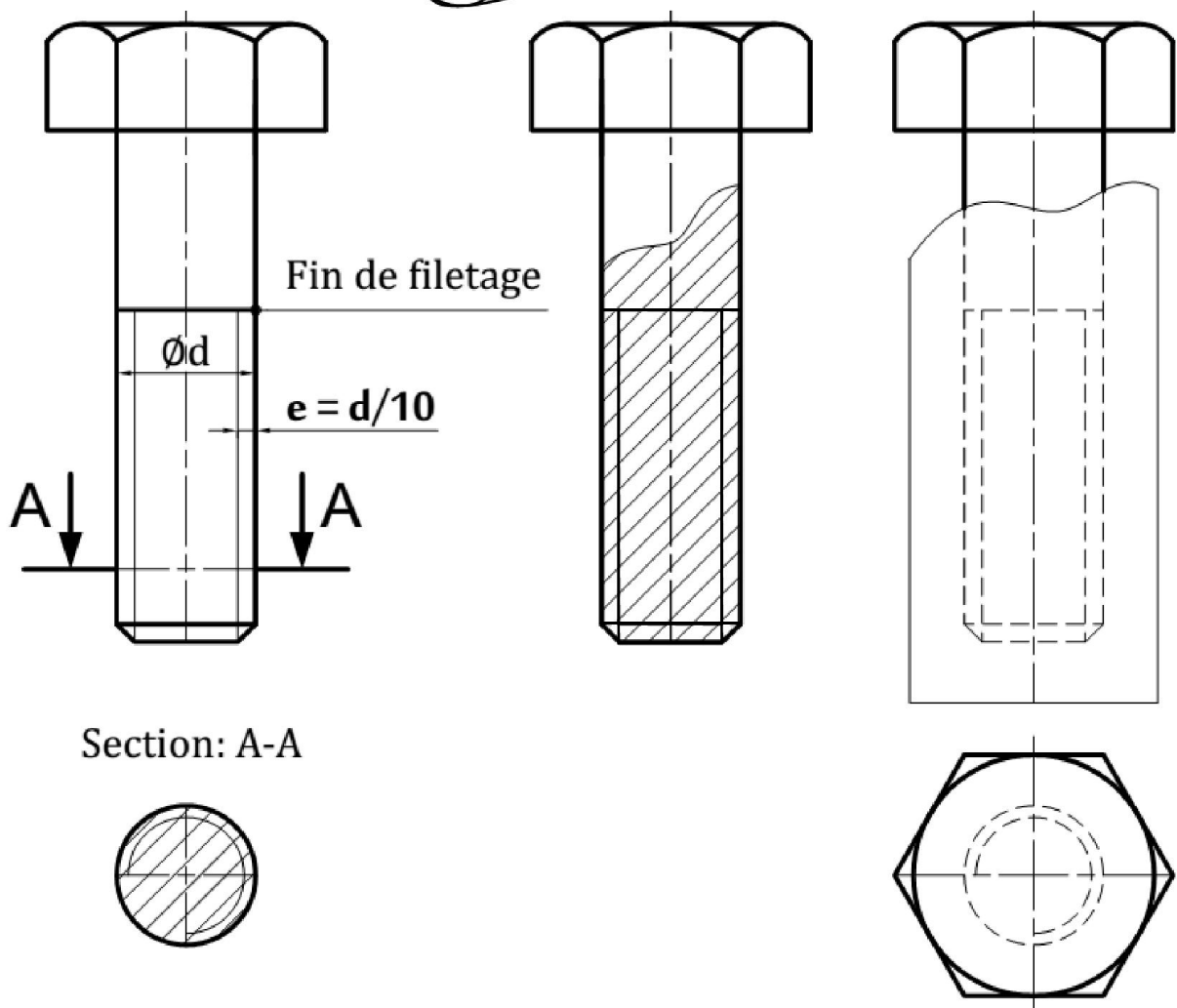

Liaisons et Assemblages

.III Taraudage

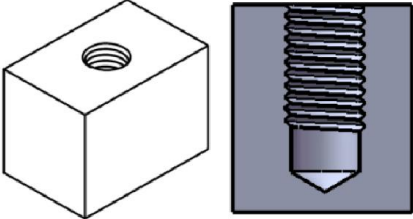
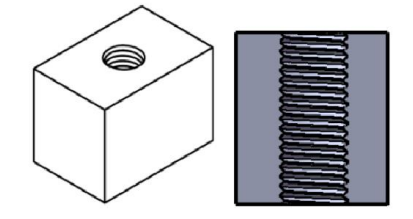
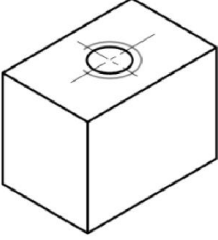
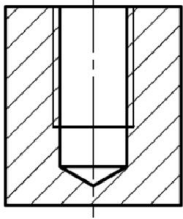
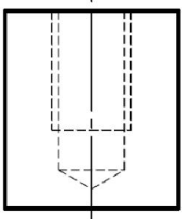
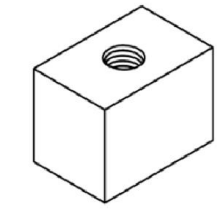
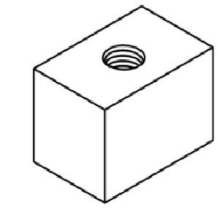
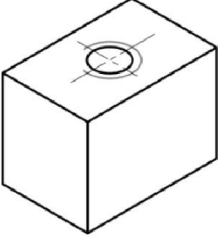
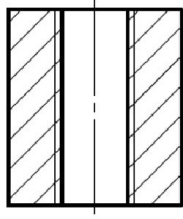
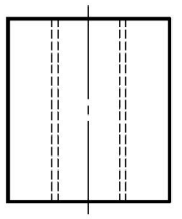
Représentation réelle		Représentation simplifiée		
				
				
		<i>En perspective</i>	<i>En coupe</i>	<i>S'il est caché</i>

.IV Assemblage des pièces Filetées

La représentation de la vis est prépondérante

IV-1 Trou débouchant

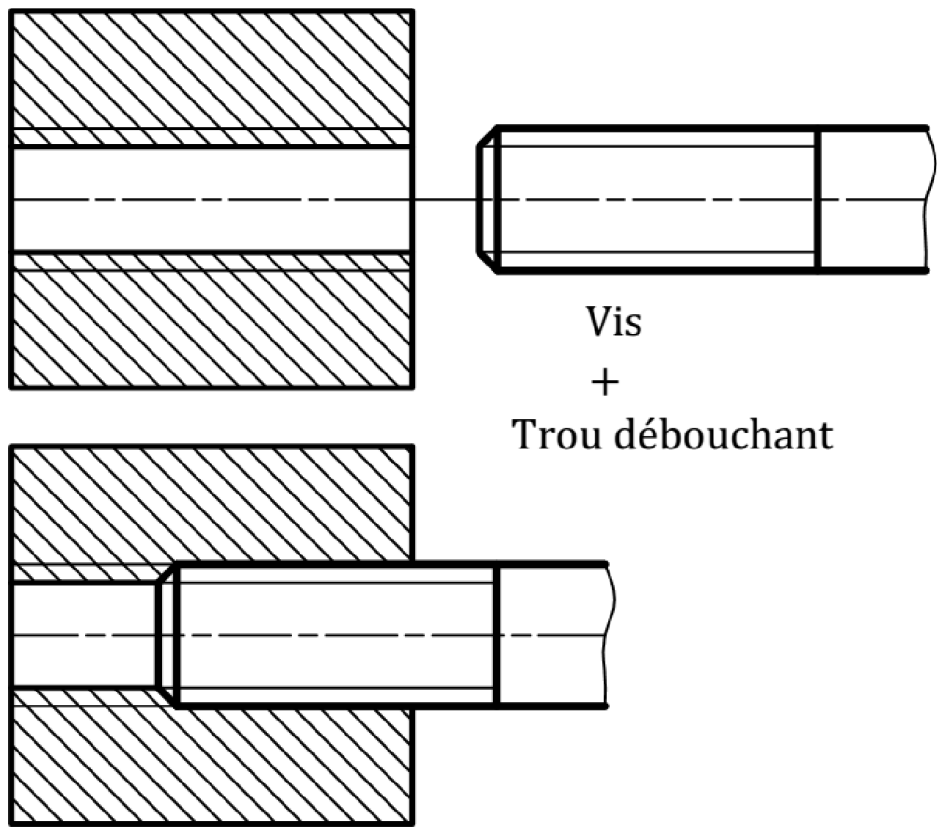

Liaisons et Assemblages

IV-2 Trou borne

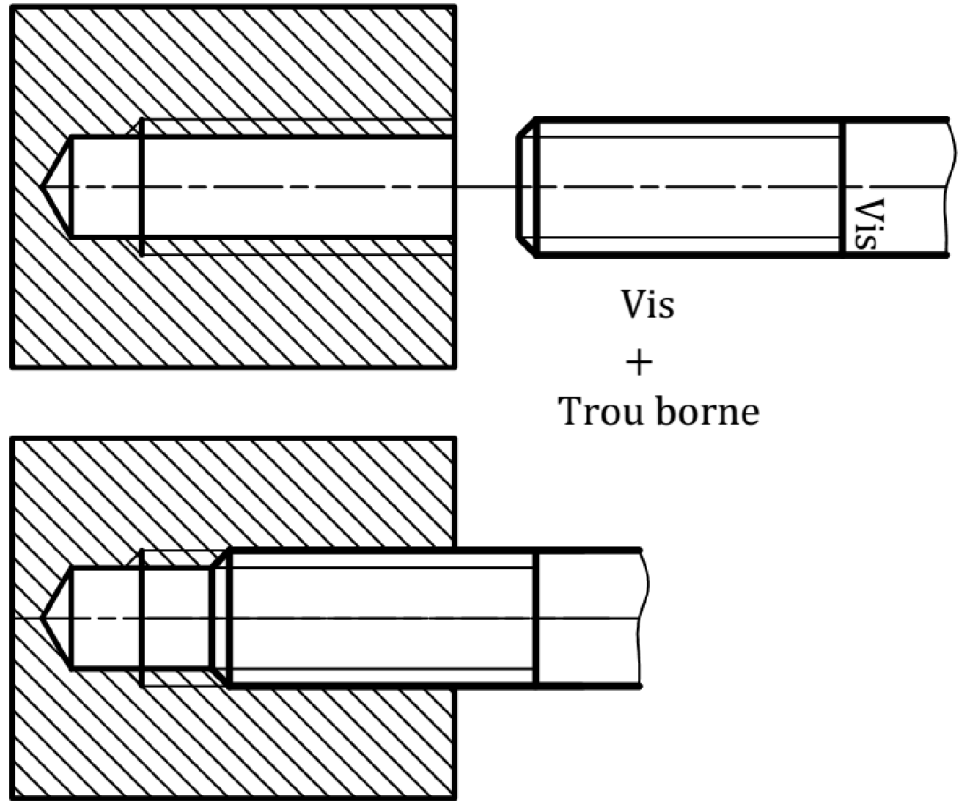

IV-3 Application

Compléter l'assemblage suivant:

